

ProV712/ProV714

USER'S GUIDE

8

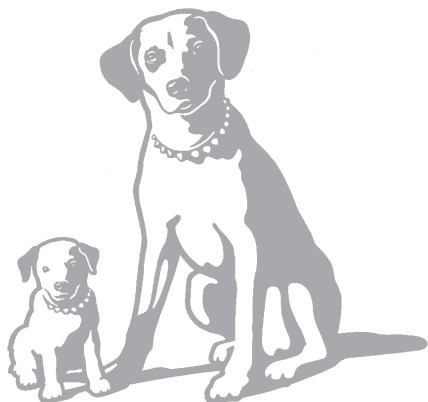

PRO8

PRO8 CAMCORDER

Important Safety Information

WARNING: TO REDUCE THE RISK OF FIRE OR ELECTRIC SHOCK, DO NOT EXPOSE THIS CAMCORDER OR ADAPTER/CHARGER TO RAIN OR MOISTURE.



CAUTION
RISK OF ELECTRIC SHOCK
DO NOT OPEN



CAUTION:

TO REDUCE THE RISK OF ELECTRIC SHOCK, DO NOT REMOVE COVER. NO USER-SERVICEABLE PARTS INSIDE. REFER SERVICING TO QUALIFIED SERVICE PERSONNEL.



This symbol warns the user of uninsulated voltage within the unit that can cause dangerous electric shocks.



This symbol alerts the user that there are important operating and maintenance instructions in the literature accompanying this unit.

CAUTION

(applies to the supplied AC adapter)

TO PREVENT ELECTRIC SHOCK, MATCH WIDE BLADE OF PLUG TO WIDE SLOT, FULLY INSERT.

CAUTION

To prevent electric shocks and fire hazards, do NOT use any other power source.

Product Registration

Please fill out the product registration card and return it immediately. Returning this card allows us to contact you if needed.

Keep your sales receipt for proof of purchase to obtain warranty parts and service and attach it here. Record the serial and model numbers located on the bottom of the camcorder.

Model No: ProV712/ProV714

Serial No: _____

Purchase Date: _____

Purchased From: _____

Assistance

We want to make sure you enjoy your new camcorder. If you have any questions, call:

Camcorder Exchange Warranty 800-283-6503 (pages 30-31)

Customer Service 800-336-1900 (page 29)

Accessories 800-338-0376 (pages 21-24)

WARNING—FCC Regulations state that any unauthorized changes or modifications to this equipment not expressly approved by the manufacturer could void the user's authority to operate this equipment.

This device complies with Part 15 of the FCC Rules. Operation is subject to the following two conditions: (1) This device may not cause harmful interference, and (2) this device must accept any interference received, including interference that may cause undesired operation.

INFORMATION

This equipment has been tested and found to comply with the limits for a Class B digital device, pursuant to Part 15 of the FCC Rules. These limits are designed to provide reasonable protection against harmful interference in a residential installation. This equipment generates, uses, and can radiate radio frequency energy and, if not installed and used in accordance with the instructions, may cause harmful interference to radio communications. However, there is no guarantee that interference will not occur in a particular installation. If this equipment does cause harmful interference to radio or television reception, which can be determined by turning the equipment off and on, the user is encouraged to try to correct the interference by one or more of the following measures:

- Reorient or relocate the receiving antenna.
- Increase the separation between the equipment and receiver.
- Connect the equipment into an outlet on a circuit different from that to which the receiver is connected.
- Consult the dealer or an experienced radio/TV technician for help.

Your Camcorder is designed to record in SP mode only. It will not perform normal playback for programs prerecorded in LP mode.

This Camcorder does not have a PCM recording or playback function. PCM recordings made using other VCRs or audio dubbing cannot be played back on this unit.

If you record on a tape on which PCM sound has already been recorded, the audio track of the new Camcorder recording may not come out if the tape is played back on a PCM-capable VCR. If this occurs, set the VCR's audio monitor select switch to the "STANDARD" position.

NOTE

The Camcorder's LCD panel is a very high technology product with close to 90,000 (ProV712)/more than 112,000 (ProV714) thin-film transistors*, giving you fine picture detail. Occasionally, a pixel may appear on the screen as a fixed point of blue, green, red, or black. Please note that this does not affect your Camcorder's performance.

*Specifications are subject to change without notice.

IMPORTANT SAFEGUARDS

In addition to the careful attention devoted to quality standards in the manufacture of your video product, safety is a major factor in the design of every instrument. However, safety is your responsibility too.

This sheet lists important information that will help to assure your enjoyment and proper use of the video product and accessory equipment. Please read them carefully before operating and using your video product.

Installation

1 Read and Follow Instructions—All the safety and operating instructions should be read before the video product is operated. Follow all operating instructions.

2 Retain Instructions—The safety and operating instructions should be retained for future reference.

3 Heed Warnings—Comply with all warnings on the video product and in the operating instructions.

4 Polarization—This video product is equipped with a polarized alternating-current line plug (a plug having one blade wider than the other). This plug will fit into the power outlet only one way. This is a safety feature. If you are unable to insert the plug fully into the outlet, try reversing the plug. If the plug still fails to fit, contact your electrician to replace your obsolete outlet. To prevent electric shock, do not use this polarized plug with an extension cord, receptacle, or other outlet unless the blades can be fully inserted without blade exposure. If you need an extension cord, use a polarized cord.

5 Power Sources—This video product should be operated only from the type of power source indicated on the marking label. If you are not sure of the type of power supply to your home, consult your video dealer or local power company. For video products intended to operate from battery power, or other sources, refer to the operating instructions.

6 Overloading—Do not overload wall outlets or extension cords as this can result in a risk of fire or electric shock. Overloaded AC outlets, extension cords, frayed power cords, damaged or cracked wire insulation, and broken plugs are dangerous. They may result in a shock or fire hazard. Periodically examine the cord, and if its appearance indicates damage or deteriorated insulation, have it replaced by your service technician.

7 Power-Cord Protection—Power-supply cords should be routed so that they are not likely to be walked on or pinched by items placed upon or against them, paying particular attention to cords at plugs, convenience receptacles, and the point where they exit from the video product.

8 Ventilation—Slots and openings in the case are provided for ventilation to ensure reliable operation of the video product and to protect it from overheating. These openings must not be blocked or covered. The openings should never be blocked by placing the video product on a bed, sofa, rug, or other similar surface. This video product should never be placed near or over a radiator or heat register. This video product should not be placed in a built-in installation such as a bookcase or rack unless proper ventilation is provided or the video product manufacturer's instructions have been followed.

9 Attachments—Do not use attachments unless recommended by the video product manufacturer as they may cause hazards.

10 Water and Moisture—Do not use this video product near water—for example, near a bath tub, wash bowl, kitchen sink or laundry tub, in a wet basement, or near a swimming pool and the like.

Caution: Maintain electrical safety. Powerline operated equipment or accessories connected to this unit should bear the UL listing mark or CSA certification mark on the accessory itself and should not be modified so as to defeat the safety features. This will help avoid any potential hazard from electrical shock or fire. If in doubt, contact qualified service personnel.

11 Accessories—Do not place this video product on an unstable cart, stand, tripod, bracket, or table. The video product may fall, causing serious injury to a child or adult as well as serious damage to the video product. Use this video product only with a cart, stand, tripod, bracket, or table recommended by the manufacturer or sold with the video product. Any mounting of the product should follow the manufacturer's instructions and use a mounting accessory recommended by the manufacturer.

11A A video product and cart combination should be moved with care. Quick stops, excessive force, and uneven surfaces may cause the video product and cart combination to overturn.

(continued on next page)

IMPORTANT SAFEGUARDS

12 Outdoor Antenna Grounding—If an outside antenna or cable system is connected to the video product, be sure the antenna or cable system is grounded so as to provide some protection against voltage surges and built-up static charges. Section 810 of the National Electrical Code, ANSI/NFPA No. 70 (Section 54 of Canadian Electrical Code, Part 1) provides information with respect to proper grounding of the mast and supporting structure, grounding of the lead-in wire to an antenna-discharge unit, size of grounding conductors, location of antenna-discharge unit, connection to grounding electrodes, and requirements for the grounding electrode. See example below.

Example of Antenna Grounding

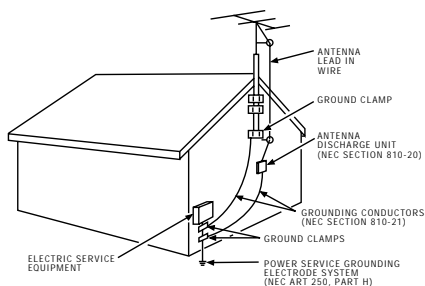

13 Power Lines—An outside antenna system should not be located in the vicinity of overhead power lines, other electric light or power circuits, or where it can fall into such power lines or circuits. When installing an outside antenna system, extreme care should be taken to keep from touching or approaching such power lines or circuits as contact with them might be fatal. Installing an outdoor antenna can be hazardous and should be left to a professional antenna installer.

Use

14 Cleaning—Unplug this video product from the wall outlet before cleaning. Do not use liquid cleaners or aerosol cleaners. Use a damp cloth for cleaning.

15 Object and Liquid Entry—Never push objects of any kind into this video product through openings as they may touch dangerous voltage points or “short-out” parts that could result in a fire or electric shock. Never spill liquid of any kind on the video product.

16 Lightning—For added protection for this video product during a lightning storm, or when it is left unattended and unused for long periods of time, unplug it from the wall outlet and

disconnect the antenna or cable system. This will prevent damage to the video product due to lightning and power line surges.

Service

17 Servicing—Do not attempt to service this video product yourself as opening or removing covers may expose you to dangerous voltage or other hazards. Refer all servicing to qualified service personnel.

18 Conditions Requiring Service—Unplug this video product from the wall outlet and refer servicing to qualified service personnel under the following conditions.

- A. When the power-supply cord or plug is damaged.
- B. If liquid has been spilled, or objects have fallen into the video product.
- C. If the video product has been exposed to rain or water.
- D. If the video product does not operate normally by following the operating instructions. Adjust only those controls that are covered by the operating instructions. Improper adjustment of other controls may result in damage and will often require extensive work by a qualified technician to restore the video product to its normal operation.
- E. If the video product has been dropped or the cabinet has been damaged.
- F. When the video product exhibits a distinct change in performance—this indicates a need for service.

19 Replacement Parts—When replacement parts are required, have the service technician verify that the replacements he uses have the same safety characteristics as the original parts. Use of replacements specified by the video product manufacturer can prevent fire, electric shock, or other hazards.

20 Safety Check—Upon completion of any service or repairs to this video product, ask the service technician to perform safety checks recommended by the manufacturer to determine that the video product is in safe operating condition.

21 Wall or Ceiling Mounting—The product should be mounted to a wall or ceiling only as recommended by the manufacturer.

22 Heat—The product should be situated away from heat sources such as radiators, heat registers, stoves, or other products (including amplifiers) that produce heat.

Precautions

Dew Formation

• What is “dew formation”?

When cold water is poured into a glass, dew drops form on the glass. This clinging of water drops is called dew formation.

• When dew forms in your Camcorder.

Dew will gradually form on the head drum of your Camcorder and make the video tape stick to the head. This causes damage both to the head and the tape. When dew formation occurs, recording and playback may not function properly.

Dew is likely to form in the following circumstances:

- when moving the Camcorder from a cold place to a warm place,
- when placing the Camcorder in a cold room which is then heated rapidly,
- when moving the Camcorder outdoors from an air conditioned room,
- when placing the Camcorder in the direct path of air blowing from an air conditioner,
- when placing the Camcorder in a humid room.



• How to prevent trouble due to dew formation.

When using the Camcorder in a place where dew formation is likely to occur, allow the Camcorder and the video tape to acclimate to the surroundings for about one hour.

For example, when bringing the Camcorder indoors after skiing, place it in a plastic bag and allow it to adapt to room conditions for some period of time.

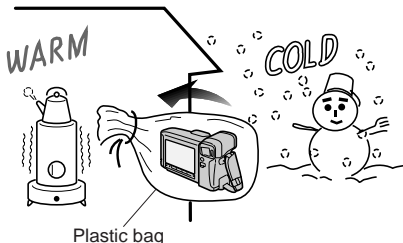

- 1 Be sure to tightly seal the plastic bag containing the Camcorder.
- 2 Remove the bag when the air temperature inside it reaches the temperature of the surroundings.

• “Dew” warning feature

If dew forms, the “DEW” indicator lights, and the power will automatically turn off in approximately 10 seconds. (See page 4)

DEW indicator

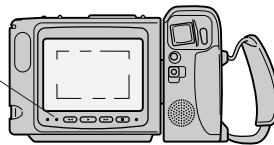

- 1 If the “DEW” indicator lights, remove the cassette, leave the cassette compartment open, and wait several hours to allow the Camcorder to acclimate to the surrounding temperature.
- 2 To use the Camcorder again, after waiting for several hours. Be sure that the “DEW” indicator has turned off.
- 3 Do not insert a cassette while the “DEW” indicator is lighting; this may result in damage to the tape.
- 4 Since dew forms gradually, it may take 10 to 15 minutes before the dew warning feature engages.

Note Do not disconnect the power source (battery pack, AC adapter, etc.) while the “DEW” indicator is lit. Wait until it goes out.

• How to continually maintain good recording

If used in a variety of places, eventually your Camcorder may not function properly due to accumulation of dirt on the head drum. Please pay special attention to the following points when using your Camcorder.

- 1) Dew formation on the head drum.
- 2) Worn video tapes:
Using a damaged or soiled video tape may also soil the head drum, causing the picture to be blurred or nothing to be recorded on the video tape. Do not use such a video tape.
- 3) Camcorder use in a humid or dusty place. Use in extremely humid or dusty places may cause damage to your Camcorder.

• When the video heads become clogged.

Using the Camcorder when the video tape is dirty may cause the head to clog, producing noise on the recorded image or preventing the image from being recorded at all.

Under such circumstances, contact the nearest RCA Customer Service or your dealer for further advice.

(Video head cleaning can be done by using a commercially available cleaning tape. However, excessive use of the cleaning tape may also cause damage to the video heads. Please read the instructions accompanying the cleaning tape carefully, before using it.)

Table of Contents

Important Information

Important Safety Information	i-ii
Important Safeguards	iii-iv
Precautions (Dew Formation)	v
Supplied Accessories	2

Preparation

Camcorder Controls	3-4
Warning Indicators	4
Powering the Camcorder From an AC Outlet	5
Using the AC Adapter/Battery Charger	6
Inserting and Removing the Battery Pack	7
Using the Optional Car Battery Adapter	8
Inserting and Removing a Cassette	9
Handling the Lens Cap and Using the Hand Strap	10
Attaching the Shoulder Strap	10
Handling the LCD Monitor Screen	10

Basic Operation

Easy Camera Recording	11
Zooming	11
Tips on Recording Positions	12
Hints For Better Shooting	13
Optical Picture Control	13
Playback	14
Volume Control	14
Video Search	14

Useful Features for Camera Recording

Self Recording	15
Auto/Manual Focus	16
Backlight Compensation (BLC) and Gain-up (Cat's Eye)	17
Macro Shots	17
Turning Off the LCD Monitor Backlight	17
Lighting	18

Connections

Connection to a TV	19
Connection to a TV Through a VCR	19
Recording with Another VCR	20

References

Optional Accessories	21
Accessory Order Form	22-24
Use and Care	25-27
Trouble Checks	28
Customer Assistance and Service	29
Limited Warranty	30-31
Specifications	32
Index (Alphabetical)	33

Supplied Accessories

This section describes only the basic steps necessary to set up your camcorder to record. Refer to the other sections for detailed operation and feature options.

Assistance

The toll-free numbers are available to help you with any problem you may encounter.

Camcorder Exchange Warranty 800-283-6503

Customer Service800-336-1900

Accessories 800-338-0376

Supplied Accessories

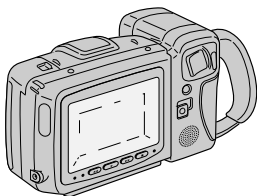

Model ProV712 or ProV714*
*Your camcorder may look slightly different from the one shown in this manual.



BATTERY PACK
Stock No. BB45

**WARNING: NICKEL
CADMIUM BATTERY
MUST BE RE-
CYCLED OR
DISPOSED OF
PROPERLY.**

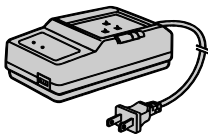

AC ADAPTER/
BATTERY CHARGER
Stock No. 221427

**CAUTION; Do not use this
adapter/charger for any
purpose other than charging
the BB45 or BB50 battery
pack or supplying power to
the camcorder.**

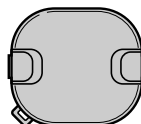

LENS CAP
Stock No. 233570

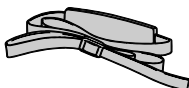

SHOULDER STRAP
Stock No. 233784

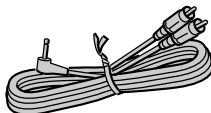

AUDIO/VIDEO CABLE
Stock No. 233568

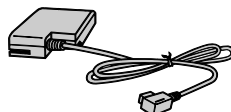

DC OUTPUT CABLE
Stock No. 233567

Camcorder Controls

For details on the use of each control, refer to the page number indicated in the brackets.

Important Information

Preparation

Front View

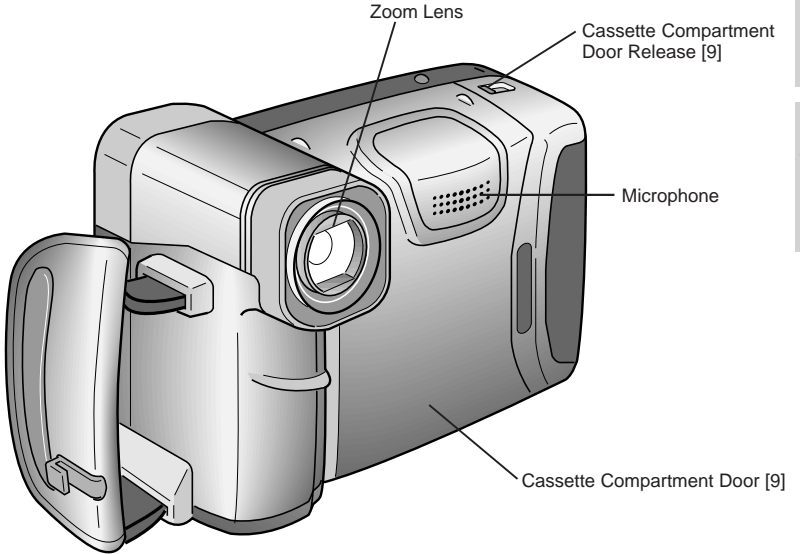

Bottom View

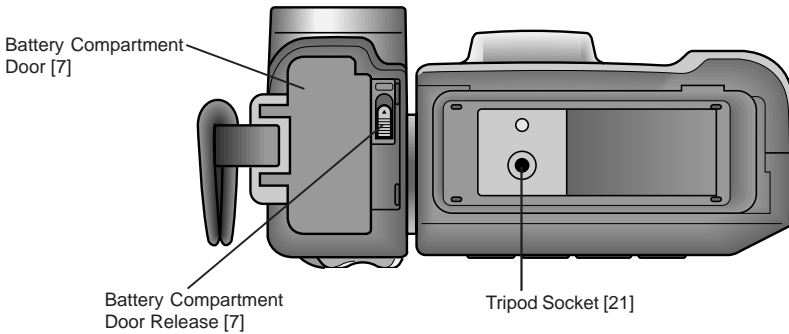

Camcorder Controls

Rear View

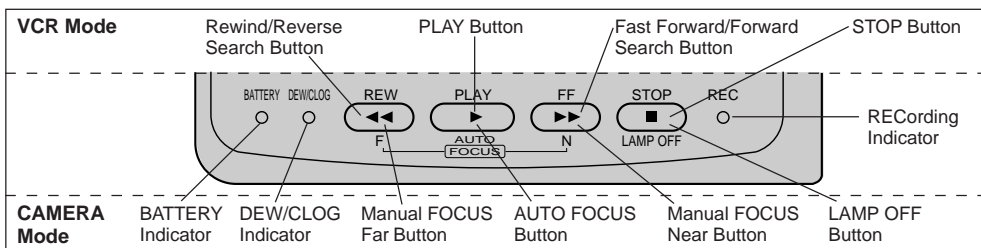
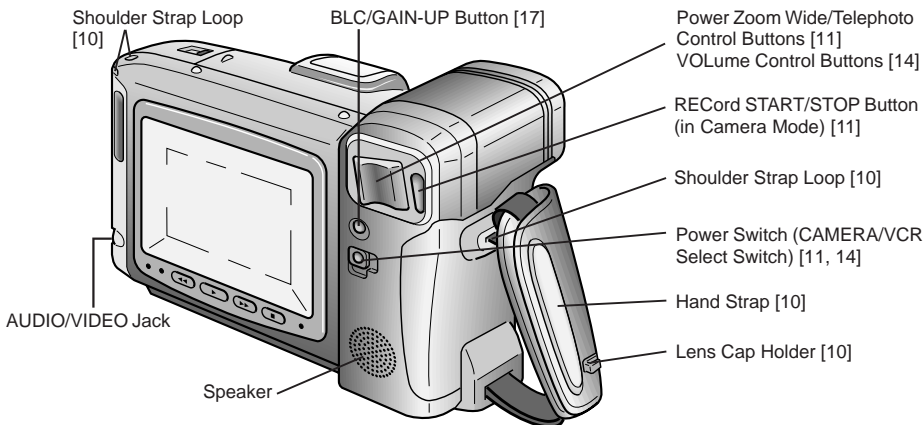

Warning Indicators

Indicator Status	Description of Warning
	<p>BATTERY indicator is flashing.</p> <p>The battery is almost depleted. Prepare a full charged battery pack for replacement.</p>
	<p>DEW/CLOG indicator is lit.</p> <ul style="list-style-type: none"> Dew has formed inside the Camcorder. Wait for a few hours to allow dew to dry (see page v). The Camcorder automatically turns off within 10 seconds after this warning operation starts. Do not disconnect the power source from the Camcorder while this indicator is lit.
	<p>DEW/CLOG indicator is flashing.</p> <p>The Camcorder's heads are dirty and should be cleaned (see page v).</p>
	<p>REC indicator is flashing.</p> <p>There is less than about one minute of tape remaining. Prepare to load a new cassette.</p>
	<p>BATTERY and DEW/CLOG indicators are flashing in sync.</p> <ul style="list-style-type: none"> The video cassette is defective and should be removed. Tape protection circuit is activated. Eject the tape from the Camcorder and reload it.

Powering the Camcorder from an AC Outlet

- 1 Slide the battery compartment door release and open the battery compartment door as shown.

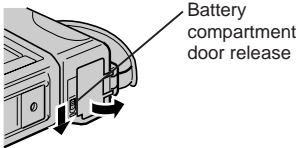

- 2 Insert the DC cable connecting plate as shown, then push it in completely.

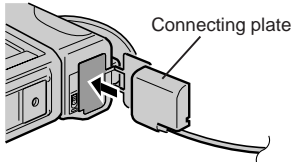

- 3 Pass the DC cable through the battery compartment notch. Close the door by pressing it firmly in the center until it clicks.

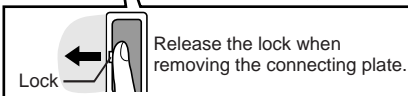
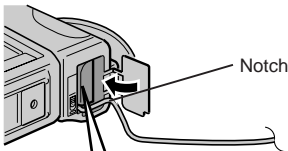

- 4 Plug the DC cable into the DC OUT jack on the AC adapter. Insert the AC adapter's AC plug into a wall outlet. The POWER indicator will light.

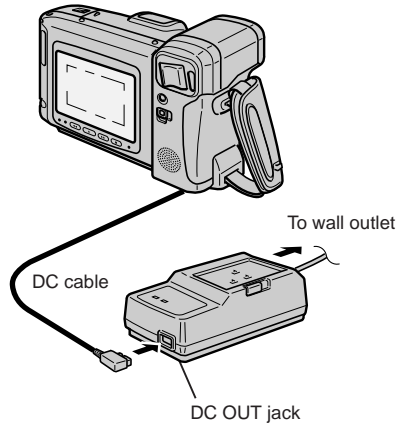

Caution This AC adapter/battery charger is specially designed for use with the Camcorder, and should not be used as a power supply for other camcorders.

Using an Optional Plug Adapter

An optional plug adapter may be required in some countries.

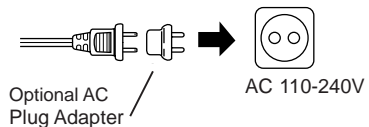

- Plug the adapter/charger's plug into the AC plug adapter.
- Plug the AC plug adapter into an AC outlet.

Using the AC Adapter/ Battery Charger

Precautions:

- The AC adapter/battery charger may interfere with reception, if used near a radio.
- Prevent flammables, liquids, and metal objects from entering the adapter/charger.
- The adapter/charger is a sealed unit. Do not attempt to open or modify it.
- Do not damage, drop, or subject the adapter/charger to vibration.
- Do not leave the adapter/charger in direct sunlight.
- Avoid using the adapter/charger in humid or extremely hot places.

Charging the Battery Pack

- 1 Disconnect the DC output cable from the AC adapter/battery charger if it is connected. Insert the AC plug into a wall outlet. The POWER indicator will light.
- 2 Align the “▼” mark on the battery pack with the “▲” mark on the charger (1). Next, press the other side of the battery pack down until it clicks into place (2). The CHARGE indicator lights.

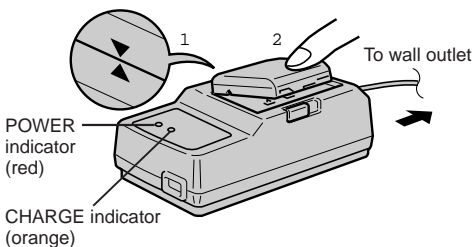

- 3 The CHARGE indicator will go off, when the battery pack is charged. Slide the BATTERY EJECT switch in the direction of arrow (1) and remove the battery pack (2). Then, unplug the charger's AC plug from the wall outlet.

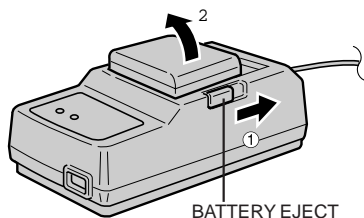

Charging Time and Maximum Time for Continuous Recording in Camera Mode

Battery Pack	Charge Time	Max. Continuous Recording Time	
		ProV712	ProV714
BB45	approx. 1 hr. 10 min.	approx. 50 min.	approx. 45 min.
BB50	approx. 3 hr.	approx. 1 hr. 35 min.	approx. 1 hr. 30 min.

Notes

- The use of the zoom and other functions and outdoor recording (see page 13) increases the power consumption, so that the actual recording time per Battery Pack may actually be 30%-50% less than the max. continuous recording time listed above.
- The battery pack and charger become warm during charging. This is not a malfunction.
- The charging time and recording time depend on the ambient temperature and the condition of the battery pack.

Extending Battery Pack Life

This Camcorder uses a Ni-Cd (nickel-cadmium) type or Ni-MH (nickel-metal hydride) type battery pack.

- After approximately nine or ten rechargings, use the battery pack until its charge is fully drained and the camcorder stops operating before recharging. This will help extend the operating time of the battery pack.
- Recharge the battery pack right before recording. A battery pack stored for an extended time will naturally wear down, resulting in decreased recording time.
- Do not try to recharge a fully charged battery pack before it has been discharged, as this will cause deterioration of the battery's capacity.
- Store the battery pack in a dry, cool place.

Cautions

- Charge only RCA model BB45 or BB50 battery packs. Other types of battery packs may burst, causing personal injury and damage.
- If the power source becomes disconnected during recording, playback, or other operations, the tape will remain wrapped around the drum, causing possible damage to the tape. Reconnect the power source to the main unit immediately.

Inserting and Removing the Battery Pack

Inserting the Battery Pack

- 1 Slide the battery compartment door release on the bottom of the Camcorder in the direction of arrow (1), to open the battery compartment door (2).

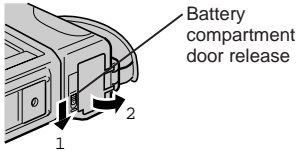

- 2 Insert the battery pack into the compartment and push it in completely.

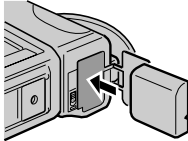

- 3 Close the door. Be sure to push firmly in the center of the door until it clicks.

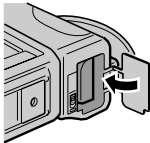

Removing the Battery Pack

- 1 Perform step 1 in the above procedure.
- 2 With the Camcorder facing down, press the lock as shown, and remove the battery pack.

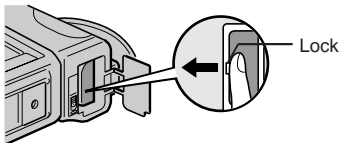

Battery Pack Handling

- Make sure that you take enough battery packs with you to provide two to three times your estimated recording time.
- Recording time will be reduced in cold weather.
- The battery will drain in Recording Standby mode. Turn off the power if you will not be recording again soon.

Cautions

- ALWAYS STOP THE TAPE AND TURN THE POWER OFF, BEFORE REMOVING THE BATTERY PACK. If you remove the battery pack during recording or playback, the tape will remain wound around the video head drum and may be damaged. Should the power source (battery or adapter) become disconnected during operation, reconnect it again immediately.
- Do not expose the battery compartment door to strong force, as it may come off.
- Be sure to close the battery compartment door firmly, especially before using the Camcorder. If you do not, the battery pack may come out or Camcorder operation may fail because of the poor contact pressure.
- Remove the battery pack from the Camcorder or disconnect the Camcorder from the AC adapter if the Camcorder will not be used for a long time.
- When removing the battery pack, do not tilt the Camcorder so that the battery compartment faces down. The battery pack may fall out.

ATTENTION: The RBRC seal on the battery used in your Thomson Consumer Electronics product indicates that we are participating in a program to collect and recycle Nickel

Cadmium batteries throughout the United States. Please call 1-800-8-BATTERY for information or contact your local recycling center.



Powering the Camcorder

Using the Optional SDC100 Car Battery Adapter

Use the optional SDC100 car battery adapter when you want to power the Camcorder from the cigarette lighter socket of your car.

Perform steps 1 through 3 under “Powering the Camcorder from an AC Outlet” (page 5).

Plug the DC cable into the DC OUT Jack on the SDC100.

Next, start the car engine and leave it idling. Then insert the plug into the cigarette lighter socket. (The POWER indicator on the SDC100 will light.)

When Powering From Your Car’s Cigarette Lighter

- See the SDC100 operation manual for details.

Notes

- Use in only DC 12 V or 24 V negative ground system cars. Positive-ground car batteries **CANNOT BE USED**. Check your car operation manual or consult a local car dealer.
- Use the SDC100 only when the car is idling or being driven. Otherwise, the car’s battery will be drained.

Cautions

- Before starting the car engine, the SDC100 must be unplugged from the cigarette lighter socket.
- Before removing either the DC plug or the cigarette lighter plug, the Camcorder’s Power switch should be set to OFF.

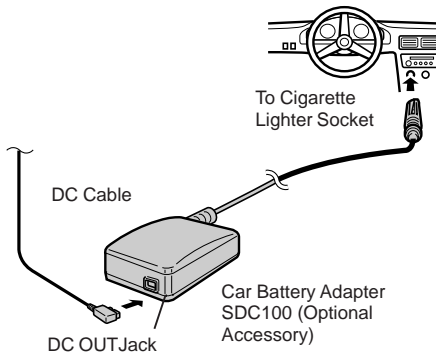

Inserting and Removing a Cassette

Inserting a Cassette

- Slide the release and open the cassette compartment door. The cassette holder extends automatically.

Cassette compartment door release

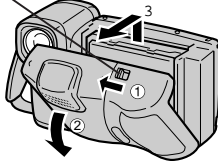

- Insert the tape cassette fully with the window facing outwards, and with the protect tab toward the top.

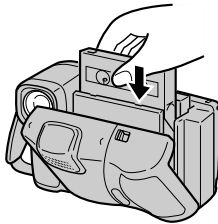

- Gently press the "PUSH" mark until the cassette holder clicks into place. The cassette holder retracts automatically.

"PUSH" mark

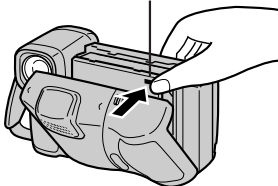

- Wait for the cassette holder to retract completely. Then close the compartment door by pressing its center until the door clicks into place.

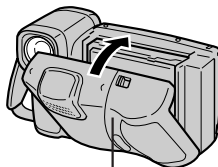

Press here.

Removing a Cassette

- Slide the release and open the cassette compartment door. The cassette holder extends automatically.
- Remove the cassette.

Cautions

- Do not try to close the cassette compartment door while the cassette holder is extending or retracting.
- Be careful not to get your fingers caught in the cassette holder.
- Do not apply force to the cassette holder except for pressing the "PUSH" mark to close it.
- Do not tilt the Camcorder or hold it upside down when a cassette is being inserted or removed. It may damage the tape.
- Remove the cassette if the Camcorder will not be used for a long time.
- If you do not press the cassette holder closed correctly in step 4, the Camcorder's cassette protection mechanism might eject the cassette. If this happens, reinsert the cassette.
- Do not attempt to pick up the Camcorder by holding the cassette compartment door.
- When the battery pack is almost empty, the cassette holder may fail to retract automatically when you close it in step 3. If this happens, replace the battery pack with a charged one. Slide the Power switch to the OFF position, and then back to the CAMERA or VCR position.

To Protect Recordings From Accidental Erasure

Slide the red tab on the tape cassette in the direction of the arrow until the red indicator is visible. When you want to record on the tape again, slide the red tab in the reverse direction.

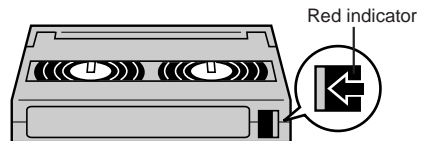

Red indicator

Preparation

Handling the Lens Cap and Using the Hand Strap

Attach the Lens Cap to the Hand Strap and Fit the Hand Strap to Your Hand

- 1 Open the hand strap flap and grip strap, and slide the lens cap holder from the grip strap as shown in the illustration below.
- 2 Pass the grip strap through the loop at the end of the lens cap cord, and replace the lens cap holder onto the strap.
- 3 Hold the Camcorder against your chest. Put your thumb close to the Power Zoom buttons, pull the grip strap tight until it fits snugly, and then close the hand strap flap.

Caution Do not swing the Camcorder by its hand strap.

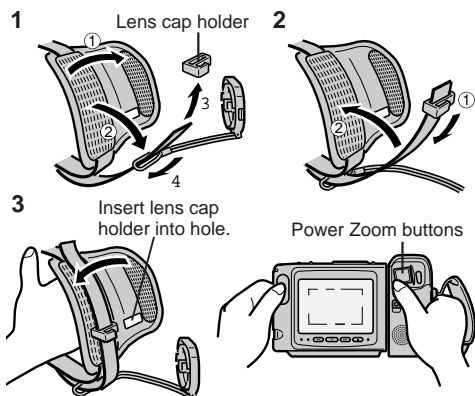

Handling the Lens Cap

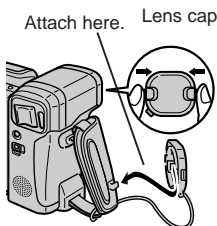

Remove the lens cap as shown and attach it to hand strap so it will not get in the way during shooting.

Note Always replace the lens cap on the Camcorder lens when the Camcorder is not in use.

Attaching the Shoulder Strap

Attach the Shoulder Strap

- 1 Hold one end of the strap and thread it through the loop on the left side of the LCD monitor screen.
- 2 Loosen the strap in the buckle, then feed through the end of the strap, as shown.
- 3 Pull the strap in the direction of arrow.
- 4, 5, 6 Repeat steps 1 through 3 to attach the other end of the shoulder strap to the ring on the lens side.

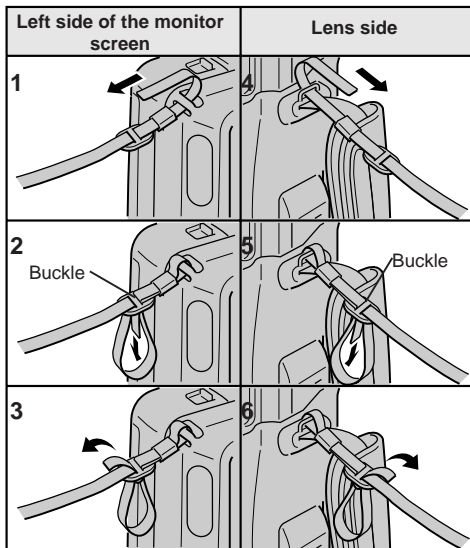

Handling the LCD Monitor Screen

- Do not let anything press against the monitor screen, and do not expose it to shock, as it may break.
- Do not put the Camcorder on a table, or any other surface, with the monitor screen facing down.
- Use a soft cloth to clean the monitor screen.

Easy Camera Recording

You can watch the subject on the large LCD monitor screen for easier, more enjoyable video-shooting.

Before you start recording, perform the operations described on pages 5 through 10 to prepare your Camcorder for recording.

- 1 Remove the lens cap and secure it to the hand strap. (See page 10)
- 2 Hold down the Power switch and slide it to CAMERA. (The picture from the lens is now displayed on the LCD monitor screen.)
- 3 Press the REC START/STOP button to start recording. Make sure the REC indicator lights.
- 4 Press the REC START/STOP button again to finish recording. The Camcorder is engaged in Recording Standby mode. Make sure the REC indicator turns off.

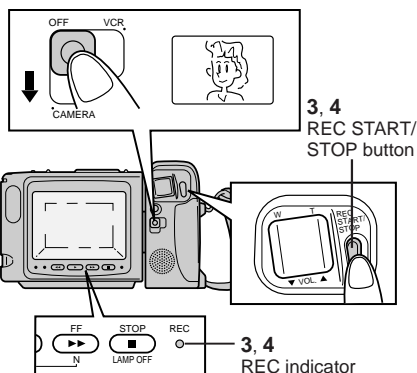

To exit Recording mode, slide the Power switch to OFF.

Notes

- During Recording mode, the speaker is off.
- If the Camcorder is kept in Recording Standby mode for more than approximately 5 minutes, the power will be automatically turned off to save battery power and to protect the tape from being damaged. To continue recording after this, set the Power switch to OFF, and then back to CAMERA again.
- If you will not be recording again for a while, turn off the power by sliding the Power switch to OFF. This will make the battery last longer.

Zooming

Zooming allows you to move visually closer to or farther from a subject without physically changing your position.

To Zoom In

Press the Power Zoom T (telephoto) button to get a close-up view when you want to focus on the subject.

To Zoom Out

Press the Power Zoom W (wide angle) button to get a wide field of view when you want to show the surroundings.

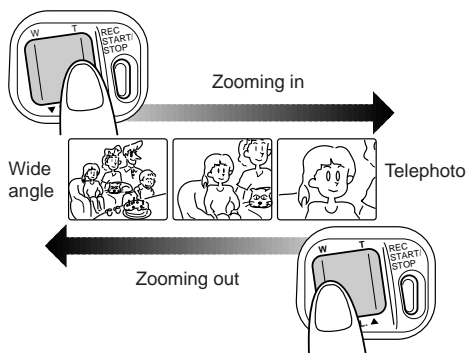

Notes

- If the REC indicator starts to flash when you press the REC START/STOP button to begin recording, check for the following and correct the situation.
 - There is less than one minute until the end of the tape is reached.
 - A blank white area may appear at the beginning of the recording if you slide the Power switch to CAMERA and then press REC START/STOP before an image has appeared on the monitor screen.

Tips on Recording Positions

The rotating LCD monitor screen lets you enjoy easy video recording in relaxed postures.

- You can record using more natural body postures since you can see the subject on-screen, without having to hold the Camcorder against your eye.
- The LCD monitor screen also makes high-angle and low-angle shots easy.
- In hand-held recording, the Camcorder has to be steadied to prevent image shake.
- Use a tripod for very stable recording.

Basic Recording Positions

Put the fingers of your right hand through the hand strap, and position your right thumb close to the REC START/STOP and Power Zoom buttons. Place your left thumb in the indentation on the left side of the LCD monitor screen.

Notes

- Take care not to touch the monitor screen with your fingers, as perspiration and dirt will smudge it.
- Unless you intend to create a special effect, keep the Camcorder level with the horizontal plane.
- Take care not to touch the microphone with your fingers when the Camcorder is recording. It will cause noise on the audio track.

Basic Posture

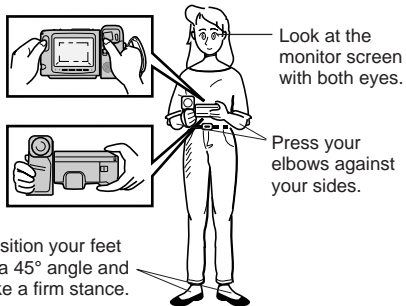

High Angle



You can record and still view the monitor screen. This is convenient when you want to record over a crowd.

Kneeling



Low Angle

When kneeling, put one knee on the ground for the best stability.



Prone

Rest on both elbows to stabilize the Camcorder.

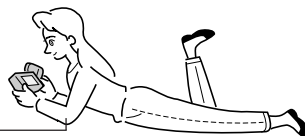

Hints for Better Shooting

Position the subject in the center of the screen.

Notes

- When you are using auto focus, whatever is in the center of the screen is kept in focus.



Position the subject in the center.



Focus manually when you need to position the subject off center (see page 16).

- Avoid backlit subjects. For the best picture, the light source should be located behind the Camcorder.
- When the background is brighter than the subject, the subject often becomes too dark. If you need to record under such conditions, use the backlight compensation (BLC) function to improve the picture (see page 17).

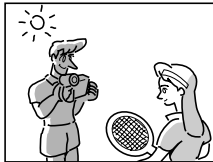

Light from behind

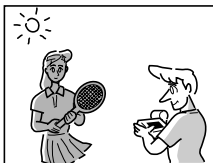

Backlighting

More Hints For Shooting Better Videos

- Before zooming, think about how to frame the shot best. Stop zooming when the shot is well framed.
- When image shake is noticeable during zoomed-in telephoto shooting, use a tripod or press the Power Zoom W (wide angle) button to zoom out. Screw the tripod into the tripod socket on the bottom of the Camcorder.
- Horizontal panning (lateral movement) and tilting (vertical movement) should be done slowly to emphasize the wide expanse of a scene or the height of a building, and to make them easy to watch on playback.
- Use wide-angle settings for fast-moving subjects.

Note It may take longer to focus when zooming and panning are used frequently.

Optical Picture Control

This function automatically causes the LCD's backlight to become brighter for easier viewing when recording outdoors.

Note Outdoor recording depletes battery pack power more quickly than indoor recording.

Basic Operations

Playback

Playback

The LCD monitor screen makes it possible to play back and see what you have just recorded. Nothing needs to be connected, allowing instant on-screen playback. You can hear the sound through the built-in speaker. You can also watch prerecorded 8 mm video tapes on this Camcorder.

- 1 Hold down the Power switch and slide it to VCR.
- 2 If the tape is not at the desired point, press the REW (or FF) button to rewind (or fast forward) the tape.
- 3 Press the PLAY (▶) button.

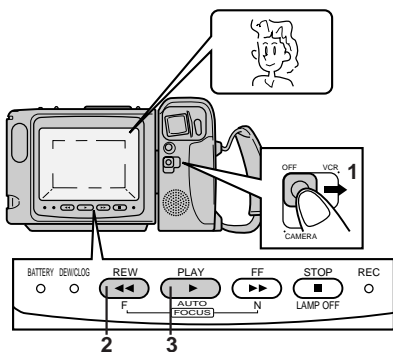

To Stop Playback

Press the STOP button (■).

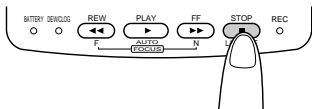

Auto Tape Rewind

The tape is automatically rewound when playback reaches the end of the tape.

Volume Control

While the Camcorder is in VCR mode, press the VOL. ▲ or ▼ button to increase or decrease the volume to your preference.

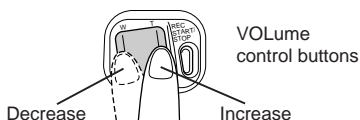

Video Search

Searching For and Playing Back a Scene Near the One Currently Being Played Back

- 1 During playback, press the FF (forward search) ▶▶ or REW (reverse search) ◀◀ button. The fast forward (or reverse) playback picture is displayed on-screen.
- 2 When you find the desired scene, press the PLAY button to return to normal playback.

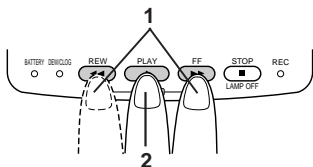

Searching for and Playing Back a Scene Far from the Current One

- 1 During fast forward (or rewind), press and hold down the FF (forward search) ▶▶ or REW (reverse search) ◀◀ button. The fast forward (or reverse) playback picture is displayed on-screen.
- 2 If the desired scene is still rather far from that point, release the Forward Search (or Reverse Search) button to return to Fast Forward (or Rewind) mode, and repeat the operation.
- 3 When you finally find the desired scene, press the STOP button and then the PLAY button to start normal playback.

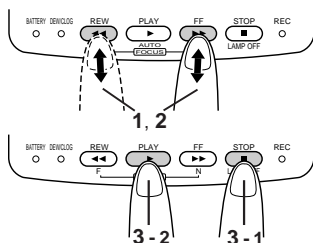

Notes

- The sound is turned off during these searches.
- Some picture noise appears during these searches. This is not a malfunction.

Useful Features for Camera Recording

Self Recording

The LCD monitor screen can be rotated 180° vertically so that the monitor screen faces the subject. This lets you record yourself while watching yourself on the monitor screen.

Example of Recording in Self Recording Mode

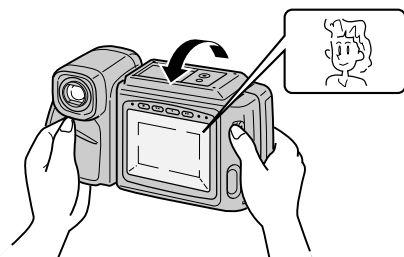

Recording yourself and your friends together at a party, while monitoring yourselves on the Camcorder's screen.

Cautions

- Do not rotate the monitor part to the self recording position while the Camcorder is recording or playing back.
- For recording in Self Recording mode, be sure to rotate the monitor part, NOT the lens. If you hold the Camcorder upside down with its lens at the bottom, the subject will be recorded upside down.

Note The screen image is automatically inverted when the monitor rotation is between 140° and 200°. When the monitor screen is turned back to its normal position, the image returns to normal.

Using Self Recording

- 1 Rotate Camcorder's monitor part 180° vertically. The screen image will be inverted to show a mirror image of the subject.
- 2 Press the Power Zoom W (Wide angle) or T (Telephoto) button to obtain the desired angle of view.
- 3 Press the REC START/STOP button to start recording. To pause recording, press the REC START/STOP button.

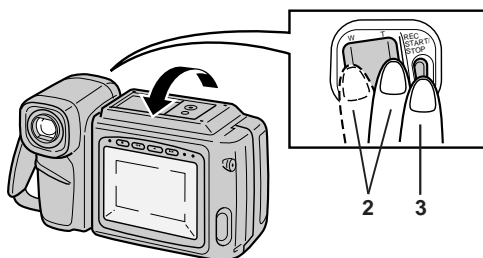

Note You can enjoy playback by sliding the Power switch to VCR, even while the monitor part is rotated 180°.

Auto/Manual Focus









Auto Focus

The Camcorder's Auto Focus feature is designed to focus on most types of subjects. In Auto Focus mode, the Camcorder automatically focuses on whatever is in the center of the scene. Therefore, always keep the subject in the center of the monitor screen.

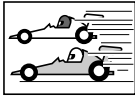
Notes

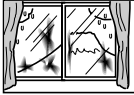
- If no subject is in the center of the monitor screen, the focus area will expand and the Camcorder will focus on the subject nearest the center.
- If no subject is displayed on the monitor screen, the Camcorder will automatically zoom out until some subject comes into the monitor screen.

Auto focus may not be able to focus correctly in the situations shown in the chart. In such situations, set the Camcorder to Manual Focus mode and focus manually.

	
Subject is too dark.	Lack of contrast, e.g. snow scene.
	
Fast-moving subject.	Background is too bright.
	
Subject has vertical or horizontal stripes.	Subject is being shot through a dirty or wet window.
	
Light reflects off the subject.	Two subjects at different distances overlap in the same scene.
	
Subject has fine, repeated patterns.	Subjects at different distances appear in the center of the scene at the same time.

Using the Manual Focus

- 1 Press the Power Zoom T button to set the zoom power to the maximum.
- 2 Press the FOCUS Far or FOCUS Near button for 1 second to set Manual Focus mode. Then press the buttons to focus on the subject.
- 3 Press the Power Zoom buttons to frame the subject as you desire.

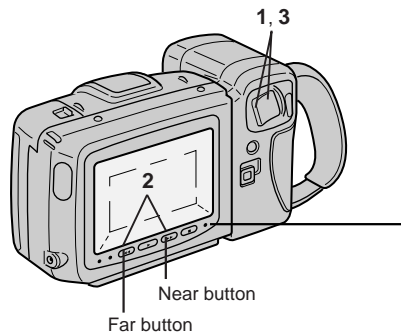

To Go Back to Auto Focus

Press the AUTO FOCUS button to set the Camcorder to Auto Focus mode.

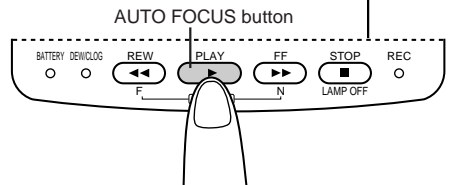

Notes

- While recording in Manual Focus mode, you may not be able to focus correctly if the subject is within approximately 5 feet (1.5 m) of the Camcorder. In such a case, shift the zoom control toward wide angle, and then try focusing again.
- If you focus on a subject without first setting the zoom power to the maximum, the subject may go out of focus when you zoom farther in on it later.
- If the lens is dirty or fogged, you may not be able to obtain correct focus.

Backlight Compensation (BLC) and Gain-up (Cat's Eye)

Backlight Compensation (BLC)

When the subject is backlit, the image will be darkened if it is recorded normally. The Camcorder's backlight compensation (BLC) feature can improve the picture.

Gain-up (Cat's Eye)

When you are recording in a dark or poorly illuminated location, the gain-up function lets you record a brighter picture.

Using BLC/GAIN-UP

- 1 Press and hold down the BLC/GAIN-UP button.
- 2 To turn off the BLC (or Gain-up) function, release the BLC/GAIN-UP button.

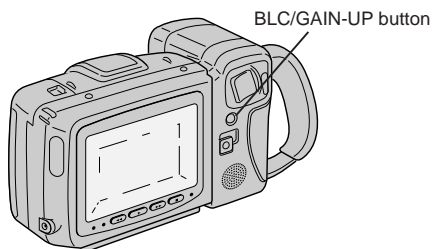

<ul style="list-style-type: none"> • When lighting is adequate, the BLC/GAIN-UP button works as "BLC" while holding it down. 	<ul style="list-style-type: none"> • When lighting is insufficient, the BLC/GAIN-UP button works as "GAIN-UP" while holding it down.

Note There is more picture noise in the Gain-up mode.

Macro Shots

This Camcorder lets you shoot close-up images of small objects such as flowers and insects or make title frames for your videos. When you want to record a magnified image of a subject which is within approximately 5 feet (1.5 m) of the Camcorder, do not zoom in on the subject. Instead, zoom out all the way by holding down the Power Zoom W button. Then move the Camcorder closer to the subject until you obtain the desired image on the monitor screen. The Camcorder will automatically focus on the subject when the lens is set for the widest angle.

Notes

- When you are recording a macro shot, be sure that there is sufficient illumination on the subject.
- It is recommended that you use a tripod for recording macro shots, to prevent camera shake.

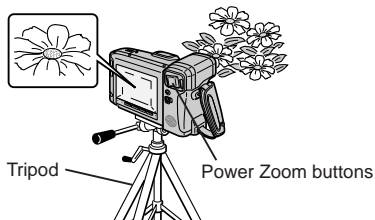

Turning Off the LCD Monitor Backlight

This Camcorder's LCD monitor screen uses a fluorescent lamp for backlighting. In order to reduce battery consumption, you can turn off the lamp when backlighting is not necessary during camera recording (e.g. when you are shooting at fixed angle when using a tripod).

During camera recording, hold down the LAMP OFF button for four seconds to turn off the lamp. To turn it on again, press the REC START/STOP button, or Power zoom button.

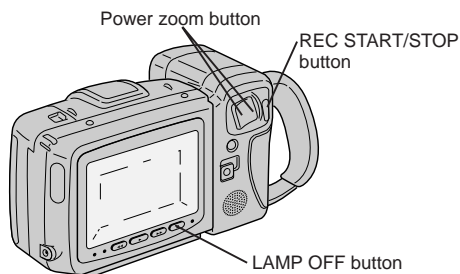

Lighting

500 to 100,000 lux of light is best for clear, good-quality recordings. Though recording is possible with less light, insufficient lighting can result in poor picture quality.

Reference

Lighting is not only one of the most important areas in producing home videos, but also one of the most overlooked. Good lighting can often mean the difference between a great picture and a poor one. Lighting is also essential for correct white balance.

In most outdoor, daytime scenes, natural lighting is adequate for home videos. Indoors, the situation becomes more complicated. Artificial lighting is required, and halogen lamps provide the most natural artificial light while maintaining a constant color temperature over a long period.

Good lighting is difficult to achieve. There are many problems waiting to catch the unwary. Simply mounting one light or several lights on either side of the Camcorder will only make your subject look flat and two-dimensional. To make a subject more interesting, use lighting to model your subject and to add or create emphasis in a scene.

Notes

- The figures in the charts are approximations.
- The auto white balance operates automatically within the range of "AUTO" shown in the chart. However, it will satisfactorily operate from 2,500 K up to 8,000 K, although the picture may take on a red or blue tint.

Brightness (Lux)	Situation (Lux)
100,000	Blue sky Clear day at noon (100,000)
10,000	Clear day at 10 am (65,000) Clear day at 3 pm (35,000) Cloudy day at noon (32,000) Cloudy day at 10 am (25,000)
1,000	Cloudy day, one hour after sunrise (2,000) Clear day, one hour before sunset (1,000) Fluorescent light near window (1,000)
100	Factory floor (700-800) Sales counter in department store (500-700) Bowling alley (500) Library (400-500) Office with fluorescent lighting (400-500) Fluorescent desk lamp (400) Flashlight at 3 ft (1 m) (250) Shop stairway (100)
10	During intermission at movie theater (15-35) Cigarette lighter at 1 ft (30 cm) (15-20) Candles on birthday cake at 8 inches (20 cm) (10-15) Candlelight

Color Temperature (degrees Kelvin)	Situation	Color	White Balance Range	
10,000	Clear day	Blue		
9,000				
8,000	Cloudy day			
7,000	Rainy day			
6,500	Daylight fluorescent light			
6,000	Camera flashbulb	White	A	
5,500			U	
5,000	Blue photolamp		T	
4,500	White fluorescent light		O	
3,500	Off-white fluorescent light Tungsten photolamp		Yellow	
3,200	Halogen lamp			
2,800	Tungsten lamp Iodine lamp			
2,500	Acetylene lamp Kerosene lamp			
2,000	Candlelight			

Connections for Playback on a TV

Although you can enjoy playback on the Camcorder's LCD monitor screen, you can also watch tape playback on your TV screen.

Connection to a TV

- 1 Connect the Camcorder to your TV with the supplied audio/video cable, as shown.
- 2 Set the TV to its "AV" or "VIDEO" channel. (See the operation manual for your TV.)

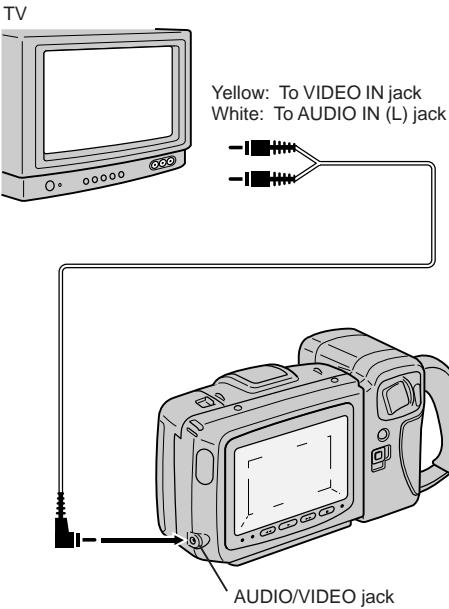

Caution Make sure that the Camcorder, TV and other equipment to be connected have been turned off before you make connections. Making connections with any of the components left turned on may cause picture noise or malfunction.

Note When the Camcorder is connected to a TV for playback, the picture on the TV screen may flicker if the volume on the Camcorder is set to maximum. Should this occur, turn the volume down (see page 14).

Connection to a TV through a VCR

- 1 Connect the Camcorder to your VCR with the supplied audio/video cable, as shown.
- 2 Set the VCR to its "LINE" or "VIDEO" input channel. Operate the TV as you normally do to see the signal from the VCR. (See the operation manuals for your TV and VCR.)

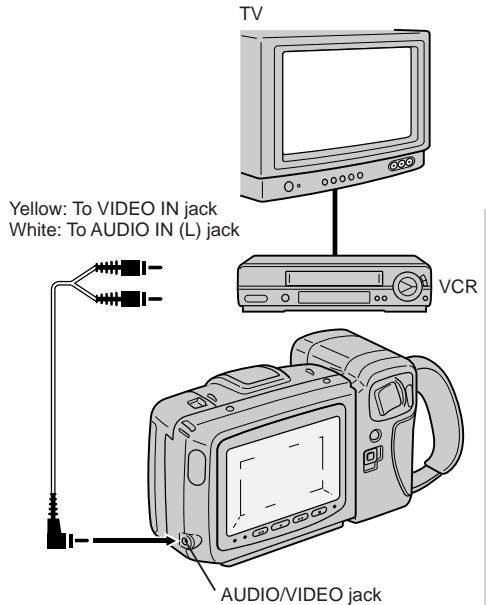

Automatic Switching of the Audio/Video Jack's Input/Output Mode

The AUDIO/VIDEO jack mode is normally set to input. It automatically switches to output when the Camcorder is playing back.

Recording with Another VCR

Your Camcorder can be used as the playback source deck for dubbing and editing a tape with another VCR.

Connect the Camcorder to a VCR with the supplied audio/video cable, as shown.

Playback

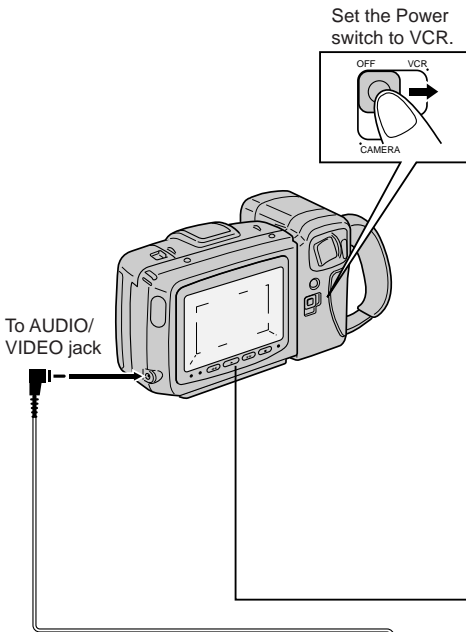

Recording

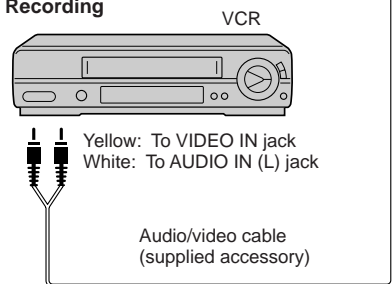

Note This Camcorder lets you monitor the source program on the built-in LCD monitor screen without having to connect it to an external TV or video monitor.

Recording with Another VCR

- 1 On the Camcorder, play back the tape to be edited, and locate the beginning and end of the sequence you wish to cut. Then rewind the tape to the beginning of the portion that you wish to keep.
- 2 Load a blank tape cassette into the recording VCR.
- 3 Press the Camcorder's PLAY button (▶) and the VCR's REC (Record) button at the same time.
- 4 Press the VCR's Pause/Still button to pause recording when the source tape reaches the beginning of the sequence to be cut.
- 5 Press the VCR's Pause/Still (or REC) button to resume recording when the source tape reaches the end of the sequence to be cut.

To Stop Dubbing

Press the Stop buttons on the Camcorder (■) and the VCR.

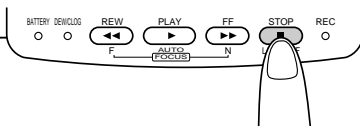

Notes

- Make sure that you press the Pause/Still button at exactly the right moments in steps 4 and 5 above. Otherwise, some of the transitions between edited sequences may be slightly off.
- The picture may be disturbed during video search picture playback. This does not imply a defect in the Camcorder.

Optional Accessories

We invite you to take a look at some great ideas for sparking creativity and adding to the fun of using your Camcorder. These accessories are designed to make the process of recording and watching your videos more enjoyable.

To order accessories, contact your local Dealer. If a dealer is not nearby, all accessories are available through toll-free ordering or by using the order form on page 23.

BB45 and BB50 Battery Packs

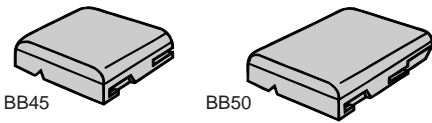

These rechargeable batteries are designed specifically for long life. The BB45 is the same battery that came packed with your camcorder. The BB50 is an extended battery pack. Both can be recharged with the adapter/charger that came with your Camcorder.

SUN102 Sun Hood



This sun hood helps protect the lens from strong sunlight when recording on a bright sunny day.

SDC100 Car Battery Adapter

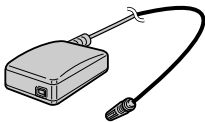

This car battery adapter enables you to operate your Camcorder from your car, truck, or RV by plugging the car cord directly into the vehicle's cigarette lighter socket. The SDC100 is designed specifically to convert power from only a 12-volt or a 24-volt negative ground car battery to a 4.5-volt output.

Caution: Do not use any other car battery adapter with Camcorder.

Using the Optional AC088 Tripod

Mounting the Camcorder on a tripod, such as AC088, will keep the camcorder steady and produce excellent video results.

This tripod's fluid-effect head provides smooth camera pan and tilt. The quick-release mount makes it easy to attach or remove the Camcorder. The grooved, tubular 3-section leg design folds down to 26 inches when not in use. Rubber feet allow for sure footing.

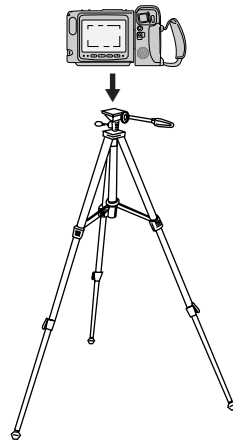

Cautions: Before using a tripod, make sure it is stable enough to hold the Camcorder without falling over. Do not transport the Camcorder attached to the tripod.

When attaching your Camcorder to a tripod, be careful not to force the tripod screw into the Camcorder's tripod mounting hole.

The tripod screw should not protrude into the camcorder more than approximately three-eighths (3/8) inch. Forcing the screw could damage the mounting hole on the bottom of the camcorder.

Accessory Order Form

To order accessories, contact your local Dealer.

If a dealer is not nearby, you can also follow the directions below to order by telephone or direct-by-mail.

United States and Canada Orders

To place your order by phone, have your Visa, MasterCard, or Discover card ready and call the toll-free number listed below between 8AM and 8PM (EST) Monday through Friday or between 9AM and 5PM (EST) Saturday.

Use this number only to place an order for accessory items listed on this order form.

1-800-338-0376

To place your order by mail, detach and mail the completed order form with credit card information, money order, or check in U.S. currency (made payable to Thomson Consumer Electronics, Inc.) to the following address:

Video Accessories
PO Box 8419
Ronks, PA 17573

Order Form for Camcorder Model ProV712/ProV714

Description	Part No.	Price	Qty.	Total
Tripod	AC088	\$ 39.95		
Rechargeable Battery (Standard Type)	BB45	\$ 59.95		
Rechargeable Battery (Extended Type)	BB50	\$ 99.95		
Car Battery Adapter	SDC100	\$119.00		
Sun Hood	SUN102	\$ 69.95		
AC Adapter/Battery Charger	221427	\$110.35		
DC Output Cable	233567	\$ 12.40		
Audio/Video Cable	233568	\$ 10.20		
Lens Cap	233570	\$ 1.50		
Shoulder Strap	233784	\$ 10.20		

Prices are subject to change without notice.

Total Merchandise \$ _____

Sales Tax \$ _____

We are required by law to collect the appropriate sales tax for each individual state, county, and locality to which the merchandise is being sent.

Shipping and Handling \$ **5.00**

Total Amount Enclosed \$ _____

Use VISA, MasterCard, or Discover.
 Money order or check must be in U.S. currency only. No COD.

Detach Here



Accessory Order Form

Charge your order on your VISA,
MasterCard, or Discover Card by
filling in below

USE YOUR CREDIT CARD



IMPORTANT: Copy complete account number
from your VISA card

My card expires:

IMPORTANT: Copy complete account number
from your MasterCard



Copy Number
above your
name on
MasterCard

My card
expires:

IMPORTANT: Copy complete account number
from your Discover Card



My card expires:

AUTHORIZED SIGNATURE

Prices are subject to change without notice.

Print or type your name and
address clearly. This will be
your mailing label.



A complete and correct
order will save you days
of waiting.

Name: _____

Street: _____

_____ Apt: _____

City: _____

State: _____ Zip: _____



Please make sure that both sides of this form
have been filled out completely.

- Allow 4 weeks for delivery.
- All accessories are subject to availability.

Precautions

- **After operation, remove the battery pack from the unit.**
- **Do not aim the lens at the sun.**
Do not allow direct sunlight to strike the Camcorder lens or LCD panel, whether recording is in progress or not, as it may damage the CCD sensor or LCD panel surface. Be particularly careful when recording outside.
- When shooting in dark places, avoid sudden brightly lit objects or light sources, such as the sun. Otherwise, the image may white out. Should this happen, point the camera in a different direction until the picture returns to normal.

- **Avoid magnetic sources.**

Using the Camcorder near strong fluorescent lights, motors, televisions, or other magnetic sources may adversely affect recorded images.

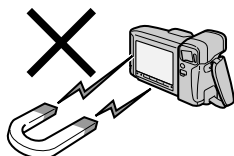

- **Remember to remove the cassette tape, turn off the power, and remove the battery pack when the Camcorder is not in use.**
- **Using the Camcorder near a broadcasting station or other powerful transmission source may cause buzzing or picture deterioration.**
- **Avoid shocks and dropping.**
Do not drop or otherwise subject the Camcorder to hard shocks or strong vibrations. Bumping or striking the unit during recording will generate noise in the recorded image.

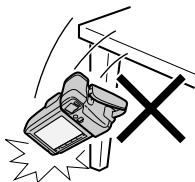

- **Watch the temperature and humidity.**

You can use your Camcorder at 0°C to +40°C (32°F to 104°F), and at 30% to 80% relative humidity. Do not store the unit in an unventilated car in the summer, in direct sunlight, or near strong heat sources; this can result in severe damage to the unit's casing and circuitry. Be careful when handling the unit after it has been left in a hot place, such as the ones described above.

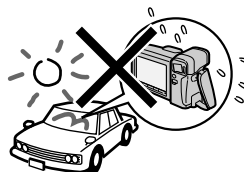

- **Avoid situations where water, sand, dust or other foreign matter could get on or inside the Camcorder. Such substances could cause malfunctions.**

Do not use your Camcorder in areas with excessive smoke or steam.

Do not leave your Camcorder in areas with excessive dust or moisture.

Such environments can cause mildew to form on this unit's lenses. Be sure to provide ample ventilation.

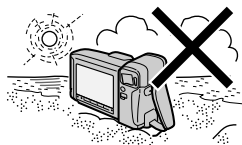

- **Some small, portable tripods may be difficult to attach and may not be sturdy enough to support your Camcorder. Be sure to use only a strong, stable tripod.**

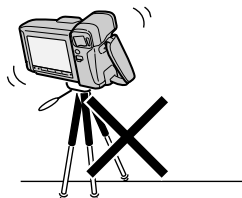

- **When you use the Camcorder at a ski resort or in some other cold environment, the LCD monitor screen may get cold giving you an image which is less bright than normal for a while after it is turned on. This is not a malfunction. If this occurs, put the Camcorder in a warmer location for some time before use. To prevent excessive cooling, wrap the Camcorder in a thick cloth (a blanket, etc.).**

Battery Packs

Battery Pack Consumption

- Recording with many starts and stops, frequent zooming, and recording in low temperatures will somewhat shorten actual recording time. Accordingly, be sure to turn off the power when not recording. Use of an auxiliary battery pack is recommended to prevent undesirable interruptions in your recording.
- Do not use an insufficiently charged or weak battery pack. Such battery packs may cause the power to automatically stop during Camcorder operation to protect both the battery pack and the unit.

Battery power is consumed even when the Camcorder's power is turned off. If the Camcorder will not be used, remove the battery pack. (See page 7.)

Note Use only the RCA BB45 or BB50 battery packs. They are designed specifically for use with this Camcorder.

Battery Pack Life

The battery pack has a limited service life. If the period of use becomes noticeably shorter with a normal charge, the battery pack is at the end of its service life. Replace it with a new battery pack.

Extending Battery Pack Life

This Camcorder uses a Ni-Cd (nickel-cadmium) type or Ni-MH (nickel-metal hydride) type battery pack.

- We recommend that you use the battery pack until its charge is fully drained and the Camcorder is inoperable before recharging the pack.
- Recharge the battery pack right before recording. A battery pack stored for an extended time will naturally wear down, resulting in decreased recording time.
- Do not try to recharge a fully charged battery pack before it has been discharged, as this will cause deterioration of the battery's capacity.
- Store the battery pack in a dry, cool place.

How to Use the Battery Pack Cover

- After the battery pack is charged, put the cover on it so that the "CHARGE" mark printed on the label is seen through the window, as shown.

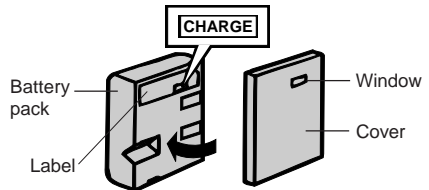

- Before the battery pack is charged, put the cover upside down so that only the battery pack casing is seen through the window.

Temperature During Charging

- The Ni-Cd (nickel-cadmium) type BB45 battery pack can be charged at temperatures of 0°C to 40°C (32°F to 104°F). To utilize the battery's full capacity, it is recommended that charging take place at temperatures of 10°C to 35°C (50°F to 95°F).
- The Ni-MH (nickel-metal hydride) type BB50 battery pack can be charged at temperatures of 10°C to 30°C (50°F to 86°F).

Caution For safety, keep the battery pack in its protective cover when it is not being used. If the metal parts of the battery pack come in contact with other metal items, there is a danger that a short circuit may occur.

Video Cassette Tapes

To Protect Recordings From Erasure

When a previously recorded cassette is used again for recording, the previously recorded material is erased. To protect a recording from accidental erasure, slide the tab on the cassette to cover the hole. (A red mark will be exposed.)

To record, slide the tab to open the hole.

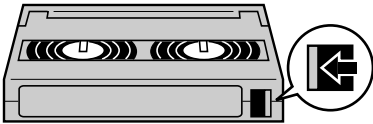

Notes

- Do not insert anything into the erasure-protection hole in the cassette.
- Use only those tapes with the **3** mark.
- **This unit is designed to operate with MP tapes, so playing back ME tapes will result in “noisy” pictures. Use MP-type tapes whenever possible.**
- Do not put anything into the holes on the bottom of the cassette.
- Do not store or place your video tapes in direct sunlight, near heaters, or in places with excessive moisture or dust.
- Do not keep video tapes near magnetic objects. They may erase the recording.
- Do not drop or subject the tapes to excessive shocks.
- Uneven tape winding will damage the tape. If the tape is not properly wound, reinsert it in the Camcorder and rewind the tape.
- Store the cassettes in their cases and stand them on edge.

Care

Cleaning and Maintenance

- Many plastic parts are used in the Camcorder casing. Do not use thinners, benzenes or other strong chemical cleaners. These may cause discoloration and damage to the casing.
- Clean the casing with a soft, dry cloth. If the casing is particularly dirty, wipe it with a tightly wrung cloth dampened with a diluted, neutral detergent. Then wipe it again with a soft, dry cloth.
- Use a soft, dry cloth to wipe finger marks and other soiling off the LCD monitor screen and lens protector.
- If the lens needs cleaning, first remove the lens cap and then clean the lens with a soft, dry cloth, or compressed air and lens papers designed for photographic lenses.

Using Your Camcorder Abroad

Television system signals and electrical system voltages and frequencies vary substantially from country to country. When you are abroad, check the sections below before using the AC adapter or connecting the Camcorder to a TV.

AC Adapter/Battery Charger (Supplied Accessory)

The supplied AC adapter is compatible with 50 Hz and 60 Hz electrical systems in the range of 100 V to 240 V AC.

Television Signal Systems

In any country, you can always watch the video picture by using the LCD monitor screen. However, if you want to watch the picture on a TV screen, the TV must be NTSC-M system compatible. NTSC-M is used in the following areas:

The Bahamas, Barbados, Bermuda, Myanmar (previously Burma), Canada, Chile, Colombia, Costa Rica, Cuba, The Dominican Republic, Ecuador, El Salvador, Greenland, Guam, Guatemala, Haiti, Honduras, Jamaica, Japan, South Korea, Mexico, The Netherland Antilles, Nicaragua, Panama, Peru, The Philippines, Puerto Rico, St. Kitts, St. Lucia, Surinam, Taiwan, Trinidad, the U.S.A., Venezuela, southern part of Vietnam, and the Virgin Islands.

Trouble Checks

Troubles sometimes are caused by simple “faults” that you can easily correct without the help of a service technician by first checking a few basic remedies.

Before you call or take your camcorder to an Authorized RCA Camcorder Servicenter, look below for the type of trouble you are experiencing. Then perform the simple checks and adjustments listed for that trouble.

If service should be necessary, the warranty information lists what your warranty covers and explains how to get service.

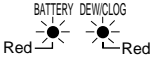
SYMPTOM		POSSIBLE CAUSE	SUGGESTED SOLUTION
Power	No power	Battery pack is not charged.	Charge battery pack sufficiently (p. 6).
		Power source is not properly connected.	Connect power source properly (pp. 5,7,8).
	Power goes off soon after coming on.	Depleted battery pack	Use a fully charged battery pack (p. 7).
		Dew in Camcorder	Wait until dew dries (pp. v, 4).
Recording	Power on but no image on monitor.	Camcorder is in VCR mode.	Set Power switch to CAMERA (p. 11).
	Cannot record.	Erasure protection hole is covered.	Slide red projection to open hole (p. 9).
	Fuzzy picture	Dust or other foreign matter on lens.	Clean lens.
Not properly focused.		Adjust focus manually or set Camcorder to Auto Focus mode (p. 16).	
Playback	No image appears on connected TV's screen.	Improperly connected to TV.	Reconnect properly (p. 19).
		TV's channel or TV's VIDEO channel not selected	Set TV to its VIDEO input channel (p. 19).
	Camcorder does not playback in color on connected TV.	Dirty video heads	Call for Customer Service.
		Video noise in image.	Worn video heads
	Old or worn tape		Use a new tape cassette (p. 9).
Cassette cannot be inserted.		Cassette is not right side up, or is backwards.	Check cassette positioning and reinsert (p. 9).
Cassette won't eject.		Camcorder is in Recording mode.	Press REC START/STOP (or STOP) button to stop tape, and try again (p. 11).
No tape movement in Fast Forward mode.		Tape already completely wound.	Rewind tape to desired point (p. 14).
No tape movement in Rewind mode.		Tape already completely rewound.	Fast forward tape to desired point (p. 14).
 <p>BATTERY and DEW/CLOG indicators are flashing in sync.</p>		Tape protection circuit is activated.	Eject the tape from the Camcorder and reload it.

Note This unit is equipped with a microprocessor. Its performance could be adversely affected by external electrical noise or interference. If this should happen, turn off the power and disconnect the unit from any power sources. Then reconnect the power sources (to resume operation).

You can reach Thomson at the following number:

800-283-6503

(Toll free inside U.S.A.)

Our toll-free Camcorder number operates from 8 a.m. to 5 p.m., CST Monday–Friday for U.S. customers only

Thomson provides a toll-free telephone number to help you with any problems you may encounter with your camcorder.

Many can be diagnosed over the phone, and if necessary, a replacement unit can be shipped to you. Please have your camcorder model/serial number and date of purchase ready when you call. If your unit is out of warranty, we will quote the cost of an exchange unit to you.

Returning equipment to Thomson for repair or exchange

If we are unable to resolve your problem over the phone, we will gladly service your unit or exchange it for a new or refurbished camcorder. Refer to the limited warranty on the reverse side to learn about your specific rights and responsibilities.

Always consult Thomson and get a Return Authorization number before returning anything! Obtain a Return Authorization (RA) number from the telephone representative before returning your equipment to avoid delays, accounting errors, or even loss of your unit.

Important information to customers who ship defective equipment to Thomson Consumer Electronics

The Thomson representative who authorized the return of your equipment will give you an RA number over the phone. They will also provide you with instructions on where and how to return your camcorder. Write the number in large, clear characters on the outside of the box. To avoid confusion and misunderstandings, shipments without an RA number clearly visible on the outside of the box will be returned to you at your expense.

For your protection, insure all shipments for full replacement value and use a reliable shipper. Thomson assumes no responsibility for warranty shipments from the customer to the factory if not shipped in the manner prescribed by Thomson.

Include a brief note describing the problem and any conversations about the problem you have had with Thomson personnel. Include your name, address, and model/serial number of your camcorder. These numbers are located on the bottom of your unit. If your camcorder is within the warranty period, please provide a copy of the bill of sale to verify purchase date. Use the original box and packing material to protect the equipment from damage in shipment.

Limited Warranty

What your warranty covers:

- Any defect in materials or workmanship.

For how long after your purchase:

- 90 days for labor charges.
- One year for parts.

What we will do:

During the initial 90 days

- Exchange your camcorder with a new or, at our option, a refurbished unit or at your option, repair your camcorder at no cost to you.

After the 90 days and within one year

- Exchange your camcorder with a new or, at our option, a refurbished unit or at your option, repair your camcorder. Parts will be provided at no charge, but you will be responsible for the cost of labor required for the repair.

How you get service:

- Call 1-800-283-6503 and have your unit's date of purchase and model/serial number ready. The model/serial number information is on the bottom of your camcorder.
- A representative will troubleshoot your problem over the phone. If the representative determines that you should receive a replacement unit, you will be provided with a Return Authorization (RA) number and the location of a nearby exchange point if one exists. No returns will be accepted without the RA number.

To receive a replacement camcorder before you return yours:

If you are located near an exchange point:

1. We will send a replacement unit to the exchange point next business day delivery.
2. The exchange location will notify you of its arrival.
3. Take your unit, including all accessories, and your bill of sale which validates date of purchase to the exchange location and you will be provided the new or refurbished unit.
4. If the repairs were covered by your warranty, you will not be billed.

If you are *not* located near an exchange point:

1. Provide your Discover, MasterCard or Visa account number and expiration date to our phone representative. This is for security purposes. If we receive your unit including all accessories within 14 days from the date you were provided a Return Authorization number, only items not covered by warranty will be charged to your account. **IF YOUR UNIT INCLUDING ALL ACCESSORIES IS NOT RECEIVED WITHIN 14 DAYS, THE SUGGESTED RETAIL VALUE OF THE CAMCORDER AND/OR ACCESSORIES WILL BE CHARGED TO YOUR CREDIT CARD.** This amount will be credited if the unit is subsequently received.
2. We will send you a replacement unit next business day delivery.
3. You will receive an invoice packed with the replacement product, but will not be charged for the unit portion of the invoice amount if we receive your unit including all accessories within 14 days from the date you were provided the RA number. Any labor and parts charges not covered by our warranty will be included and charged against your account.
4. Ship the unit back to us along with all accessories included with your camcorder using the replacement unit's carton. Shipping instructions will be included in the carton along with your RA number, which will allow you to easily ship the unit back to us. **Make sure you insure your shipment in case of damage or loss.**
Include with the shipment:
 - A copy of your dated bill of sale to verify your unit's warranty eligibility.
 - A brief note describing your camcorder problem.
 - Your name, address, and phone number.

Return transportation, storage, and handling costs and insurance are your sole responsibility. We accept no liability in case of damage or loss.

To receive a replacement unit after we have received your unit:

1. Write the RA number on the outside of the carton used to return the unit.
Make sure you insure your shipment in case of damage or loss.
2. Carefully pack the unit along with all accessories included with your camcorder, using the original box and packing material if possible.
3. Include with the shipment:
 - A copy of your dated bill of sale to verify your unit's warranty eligibility.
 - A brief note describing your camcorder problem.
 - Your name, address, and phone number.

Return transportation, storage, and handling costs, and insurance are your responsibility. We accept no liability in case of damage or loss.

4. Include a cashier's check or money order for payment if there are any out of warranty labor or parts charges which were indicated by the representative, and you elected not to use your credit card.
5. Upon receipt of your product, a new or refurbished unit will be shipped to you next day delivery.

To have your Camcorder repaired by an Authorized RCA Camcorder Servicenter:

- Check with your dealer or call 1-800-336-1900 for the Authorized RCA Camcorder Servicenter nearest you.
- Take your unit to the Authorized RCA Camcorder Servicenter of your choice.
- Show the Authorized RCA Camcorder Servicenter representative your sales receipt or other, evidence of purchase.
- Pick up your camcorder when repairs are complete.

What your warranty does not cover:

- Adjustment of customer controls.
- Damage from misuse or neglect.
- A unit that has been modified or incorporated into other products or is used for institutional or other commercial purposes.
- Battery for clock and other features.
- Cleaning of video/audio heads.
- Camcorders purchased or serviced outside the U.S.A.
- Return transportation, storage and handling costs of your unit, including insurance for loss or damage.
- Acts of God, such as but not limited to lightning damage.

Product Registration:

- Please complete and mail the *Product Registration Card* packed with your camcorder. It will make it easier to contact you should it ever be necessary. The return of the card is not required for warranty coverage.

How State Law relates to warranty:

- This warranty gives you specific legal rights and you may have other rights that vary from state to state.

If you purchased your Camcorder outside the United States:

- Contact your dealer for warranty information.

Specifications

Specifications

Signal System:	NTSC standard
Recording System:	2 rotary heads, helical scanning system
Cassette:	8 mm video tape, MP type
Recording/Playback Time:	120 minutes (P6-120)
Tape Speed:	14.345 mm/second
Pickup Device:	1/4" (6.4mm, effective size: 4.5 mm) CCD image sensor with approx. 270,000 pixels including optical black
Lens:	12 × power zoom lens (F1.8, f=4.2-50.4 mm) and full-range auto focus
Lens Filter Diameter:	37 mm
Monitor:	ProV712: 3" (7.5 cm), ProV714: 4" (10 cm)—full-color LCD screen (TFT active matrix)
Microphone:	Electret monaural microphone
Power Requirement:	DC 3.6 V
Power Consumption:	ProV712: 5.6 W, ProV714: 5.8 W (during indoor camera recording in Full Auto mode with zoom motor off)
Operating Temperature:	0°C to +40°C (32°F to 104°F)
Operating Humidity:	30% to 80%
Storage Temperature:	-20°C to +60°C (-4°F to 140°F)
Dimensions (approx.):	7 ¹³ / ₃₂ " (W) × 4 ¹³ / ₁₆ " (H) × 3 ⁵ / ₈ " (D) [188 mm (W) × 122 mm (H) × 92 mm (D)]
Weight (approx.):	ProV712: 1.63 lbs (740 g), ProV714: 1.68 lbs (760 g) (without battery pack, video cassette, and lens cap)

AC Adapter/Battery Charger

Power Requirement:	AC 100-240 V, 50/60 Hz
DC Output:	4.5 V
Power Consumption:	27 W
Dimensions (approx.):	2 ³¹ / ₃₂ " (W) × 2" (H) × 5 ⁵ / ₁₆ " (D) [75 mm (W) × 51 mm (H) × 135 mm (D)]
Weight (approx.):	0.71 lbs (320 g)

- Accessories, Included 2,22-24
- Accessories, Optional 21-24
- Accessory, Order Form 22-24
- Adapter/Charger, Using 6
- Assistance i,2,29
- Attaching the Lens Cap and Hand Strap 10
- Attaching the Shoulder Strap 10
- AUDIO/VIDEO Jack 4,19-20
- Auto Focus 16
- Auto Tape Rewind 14
- Backlight Compensation 17
- Backlight, Monitor 17
- Basic Operations 11-14
- Battery Compartment 3,5,7
- Battery Indicator 4
- Battery Pack 6,7,26
- Battery Pack, Use and Care 26
- Battery Pack, Using to Power the
 - Camcorder 7
- BLC/GAIN-UP Button 4,17
- Camcorder Controls 3-4
- CAMERA/OFF/VCR Switch 4,11,14
- Car Battery Adapter, Using 8
- Cassette Compartment Door 3,9
- Cassette Compartment Door Release 3,9
- Cassette, Inserting and Removing 9
- Cassette Tapes 9,27
- Cautions i-v
- Charging the Battery Pack 6
- Checks, Trouble 28
- Connections, Playback on a TV 19
- Connections, Playback Through a VCR 19
- Connections, Recording With Another
 - VCR 20
- Contents 1
- Copying Tapes 20
- Customer Assistance i,2,29
- Customer Assistance and Service 29
- Design Specifications 32
- Dew Warning v,4
- DEW/CLOG Indicator v,4
- Dubbing 20
- FF (Fast Forward) Button 4,14
- FOCUS Buttons 4,16
- Focus, Auto and Manual 16
- Hand Strap 4,10
- Important Safeguards iii-iv
- Important Safety Information i,ii
- Included Accessories 2,22-24
- Indicators, Warning 4
- Inserting and Removing a Cassette 9
- LAMP OFF Button 4,17
- LCD Monitor Backlight 12,17
- LCD Monitor Screen 17
- Lens Cap 10
- Lens Cap Holder 4,10
- Lighting Requirements 18
- Limited Warranty 30-31
- Macro Shots 17
- Manual Focus 16
- Microphone 3
- Monitor Screen, Handling 10
- Optional Accessories 21
- Order Form, Accessory 22-24
- PLAY Button 4,14,20
- Playback 14
- Playback Connections 19
- Power Zoom Buttons 4,11
- Powering the Camcorder 5-8
- Precautions, Use and Care v, 25-27
- Problem Solving 28
- Product Registration i
- REC Indicator 11
- RECORD START/STOP Button 4,11,15
- Recording 11-13,15-18
- Recording Indicator 4
- Recording Tips 12-13
- Recording With Another VCR 20
- Registration Card i
- REWIND Button 4,14
- Safety Tab 9,27
- Self Recording 15
- Shoulder Strap Loop 4,10
- Shoulder Strap, Attaching 10
- Solving Problems 28
- Speaker 4
- Specifications 32
- STOP Button 4,14
- Table of Contents 1
- Tape Copying 20
- Tapes, Cassette 9,27
- Tips on Recording 12-13
- Traveling Tips 27
- Tripod Socket 3,21
- Trouble Checks 28
- Use and Care Precautions 25-27
- Using an AC Outlet to Power the
 - Camcorder 5
 - Using the Adapter/Charger 5,6
 - Using the Battery Pack 6,7,26
- Video Search 14
- VOLUME Control 4,14
- Warning Indicators 4
- Warranty, Limited 30-31
- Zoom Buttons 11,16,17
- Zoom Lens 3,11
- Zooming 11

Need Assistance? We want to help!

U.S. Consumers:

Camcorder Exchange Warranty.....	800-283-6503
Customer Service	800-336-1900
Accessories	800-338-0376

Canadian Consumers:

English	800-522-0338
French	800-522-0445

Please do not send any products to the Indianapolis address listed in this manual or on the carton. This will only add delays in service for your product.

 **THOMSON CONSUMER ELECTRONICS**
10330 N Meridian Street
Indianapolis, IN 46290

©1996 Thomson Consumer Electronics, Inc.
Trademark(s) ®Registered
Marca(s) Registrada(s)
Printed in Japan

Part Number 96-ProV712/ProV714-1

TINSE0207TAZZ